







CLADDING





CEPHE KAPLAMASI

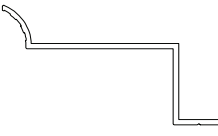

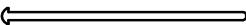
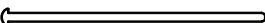
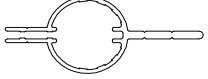
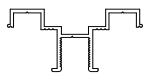
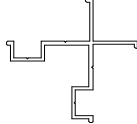
www.ayderaluminum.com.tr

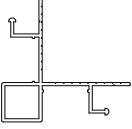

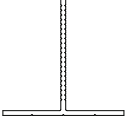
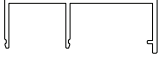
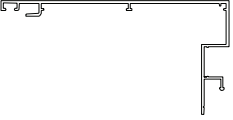
PROFİL PROFILE	PROFİL NO PROFILE NUMBER	AĞIRLIK Kg/m WEIGHT	I_x cm ⁴	I_y cm ⁴	TANIM DESCRIPTION	SAYFA NO
	C-5800-15	0.866 Kg/m			Cladding Lambiri	10
	C-5801-15	0.967 Kg/m			Cladding Lambiri	10
	C-5802-15	1.290 Kg/m			Cladding Lambiri	10
	C-5802-15	0.273 Kg/m			Cladding Açılı Dönüş Profili	11
	C-5804-20	0.634 Kg/m			Cladding Açılı Dönüş Profili	11
	C-5805-20	0.318 Kg/m			Cladding Dönüş Profili	11
	C-5806-20	0.453 Kg/m			Cladding Dönüş Profili	11
	C-5807-20	0.583 Kg/m			Cladding Dönüş Profili	11
	C-5808-20	0.770 Kg/m			Cladding Dönüş Profili	11
	C-5809-12	0.389 Kg/m			Cladding Taşıyıcı Profili	12
	C-5810-12	0.427 Kg/m			Cladding Taşıyıcı Profili	12

PROFIL PROFILE	PROFİL NO PROFILE NUMBER	AĞIRLIK Kg/m WEIGHT	Ix cm ⁴	Iy cm ⁴	TANIM DESCRIPTION	SAYFA NO
	C-5811-12	0.503 Kg/m			Cladding Taşıyıcı Profili	12
	C-5812-12	0.325 Kg/m			Cladding Tırnak Profili	12
	C-5813-12	0.516 Kg/m			Cotta T Profili	12
	C-5815-12	0.274 Kg/m			Cotta Çita Profili	12
	C-58114-12	0.956 Kg/m			Cladding Lambiri	13
	C-5815-12	1.093 Kg/m			Cladding Lambiri	13

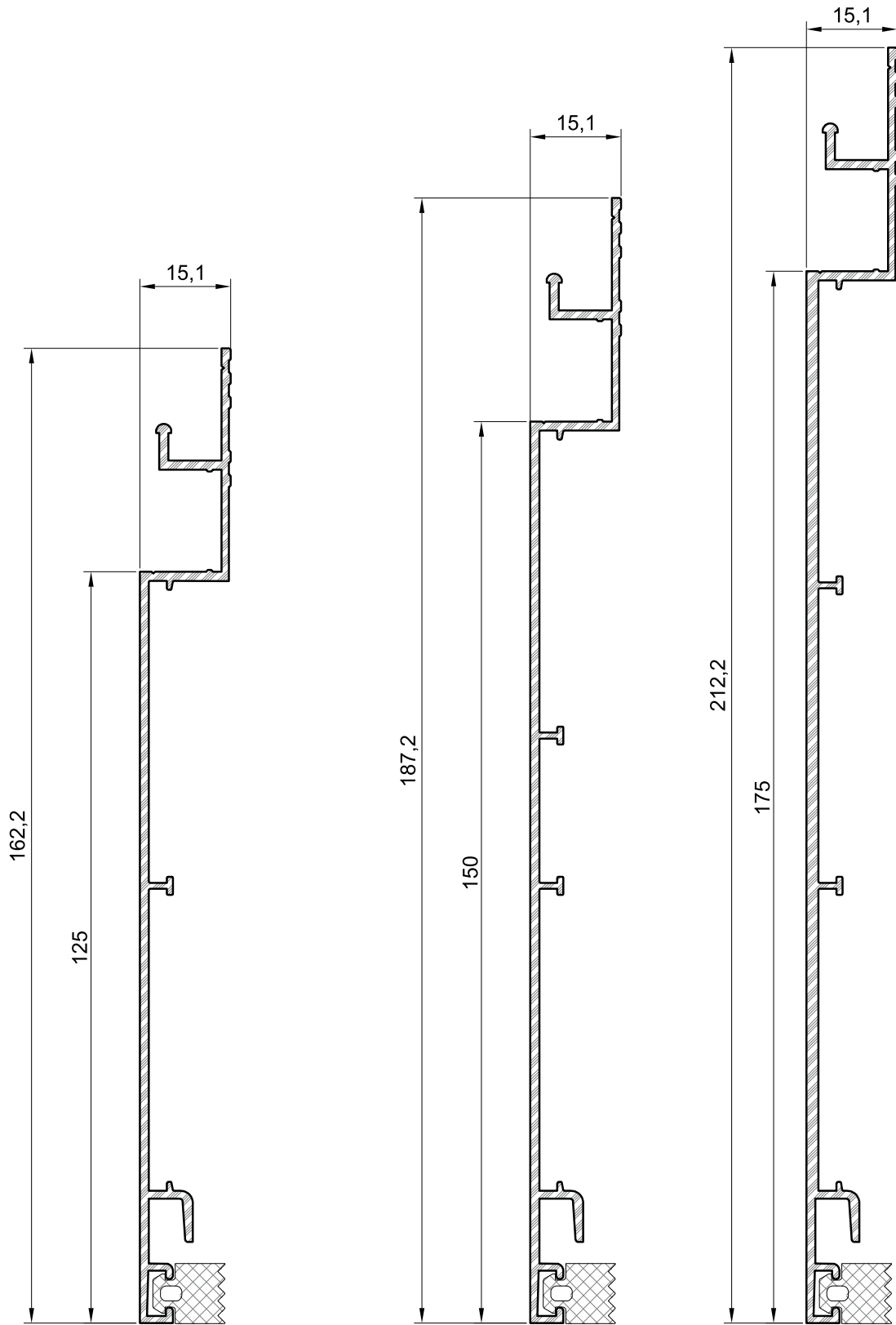

C-5800-15	
Kg/m	0.866 Kg/m
Cladding Lambiri	

C-5801-15	
Kg/m	0.967 Kg/m
Cladding Lambiri	

C-5802-15	
Kg/m	1.290 Kg/m
Cladding Lambiri	

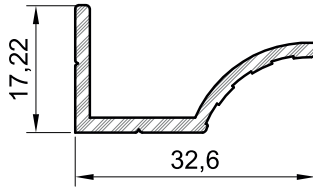

C-5803-20	
Kg/m	0.273 Kg/m
Cladding Açılı Dönüş Profili	

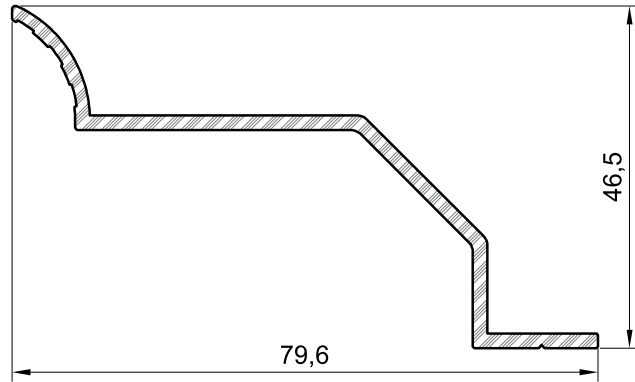

C-5804-20	
Kg/m	0.634 Kg/m
Cladding Açılı Dönüş Profili	

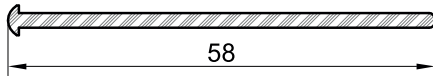

C-5805-20	
Kg/m	0.318 Kg/m
Cladding Dönüş Profili	

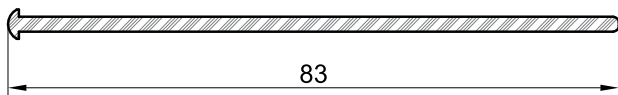

C-5806-20	
Kg/m	0.453 Kg/m
Cladding Dönüş Profili	

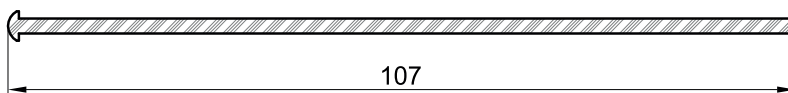

C-5807-20	
Kg/m	0.583 Kg/m
Cladding Dönüş Profili	

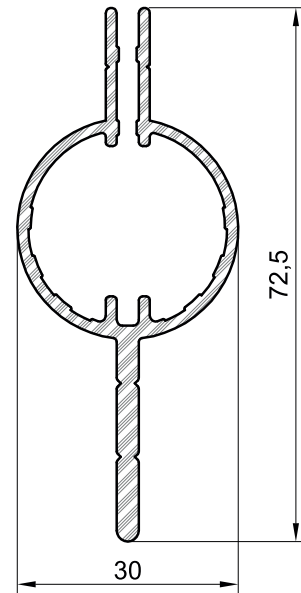

C-5808-20	
Kg/m	0.770 Kg/m
Cladding Dönüş Profili	

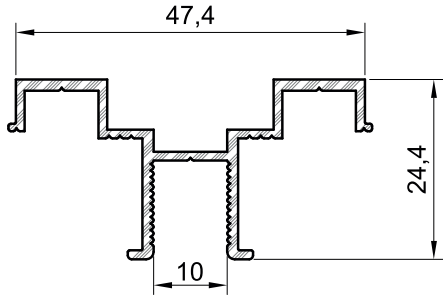

C-5809-12	
Kg/m	0.389 Kg/m
Cladding Taşıyıcı Profili	

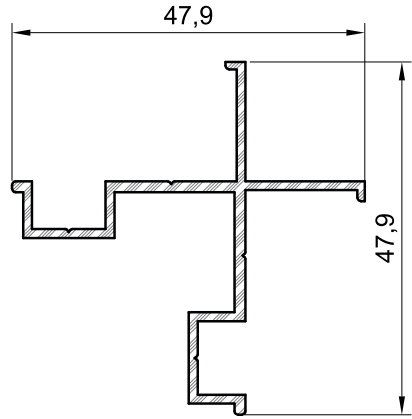

C-5810-12	
Kg/m	0.427 Kg/m
Cladding Taşıyıcı Profili	

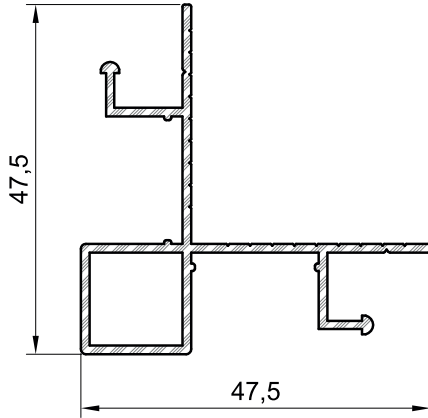

C-5811-12	
Kg/m	0.503 Kg/m
Cladding Taşıyıcı Profili	

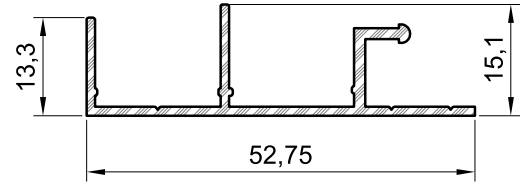

C-5812-12	
Kg/m	0.325 Kg/m
Cladding Tırnak Profili	

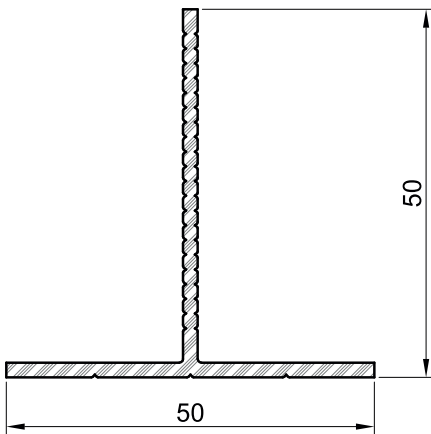

C-5813-12	
Kg/m	0.516 Kg/m
Cladding T Profili	

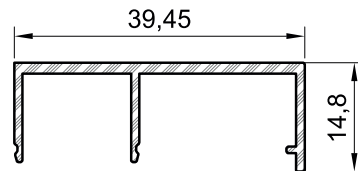

C-5815-12	
Kg/m	0.274 Kg/m
Cladding Çıta Profili	

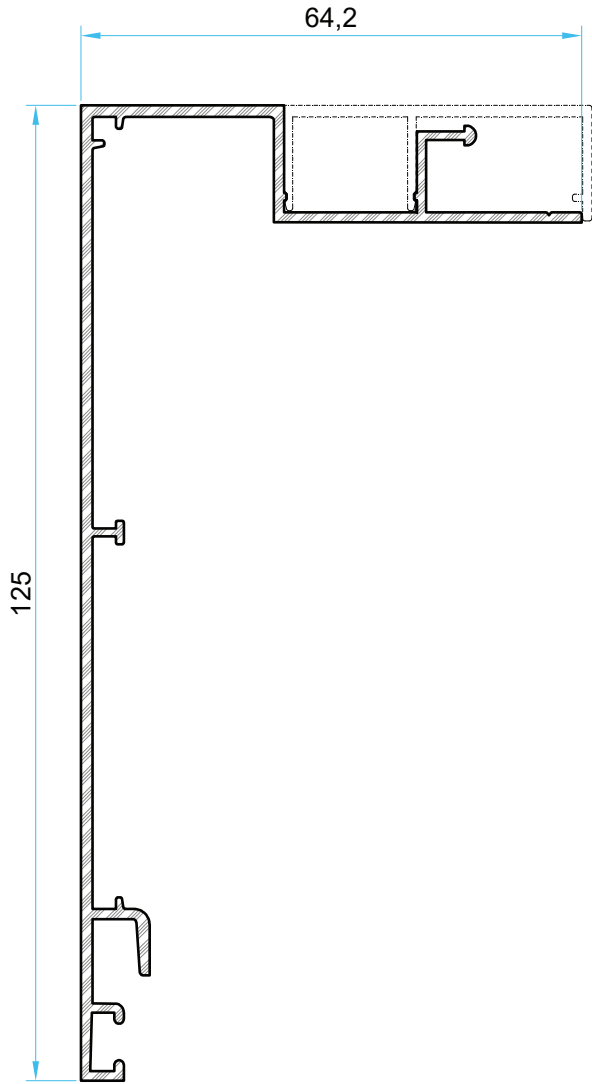

C-58114-12	
Kg/m	0.956 Kg/m
Cladding Lambiri	

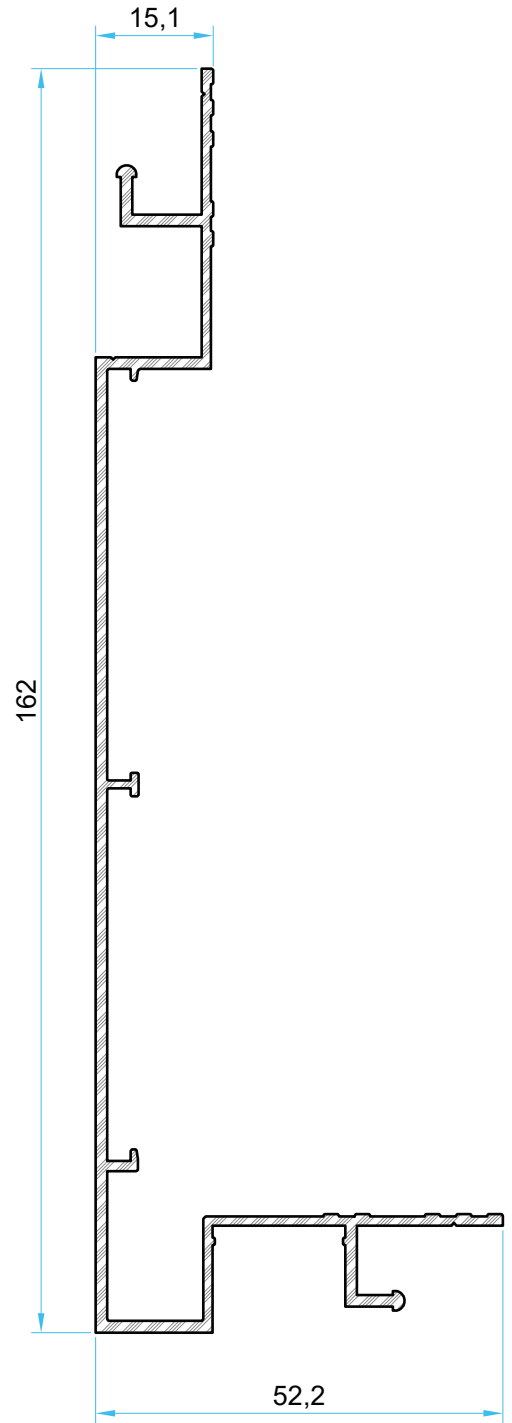

C-5815-12	
Kg/m	1.093 Kg/m
Cladding Lambiri	

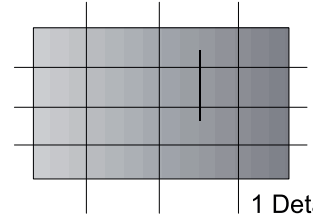

1 Detayı

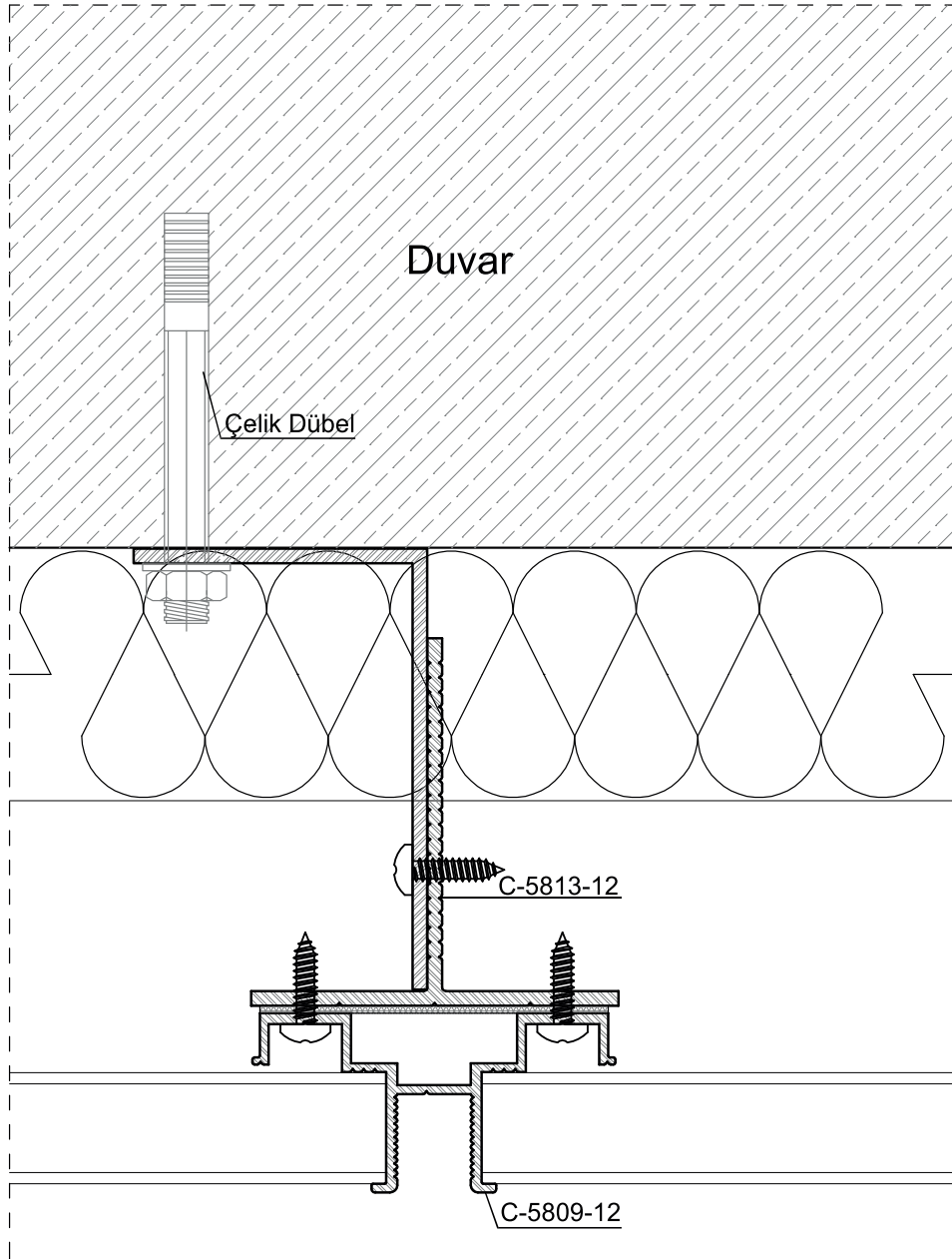

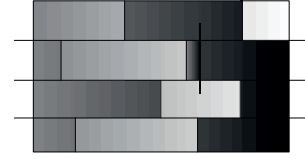

2 Detayı

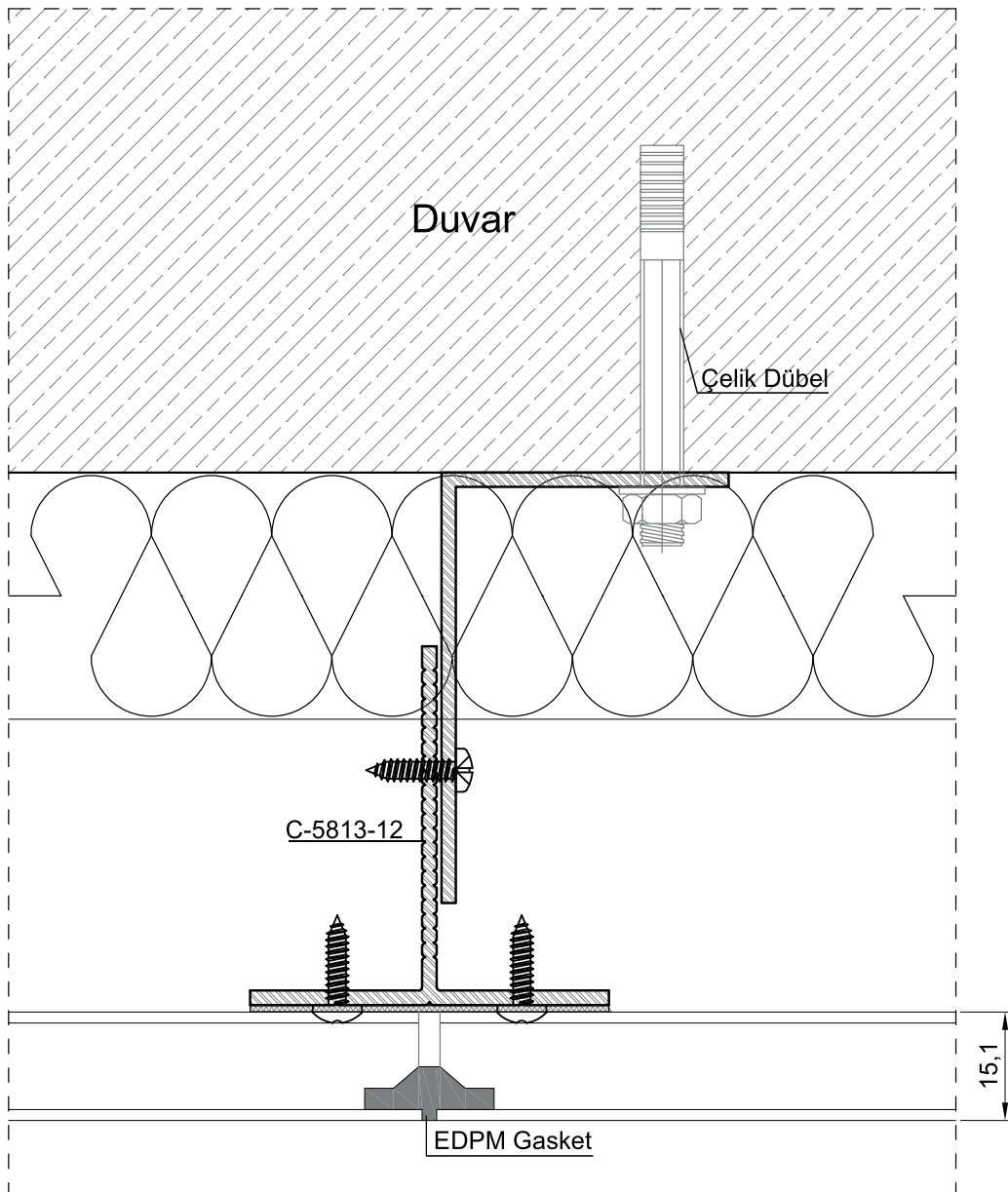

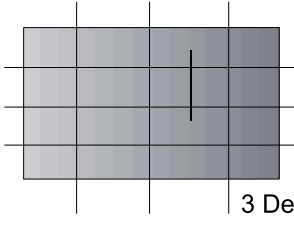

3 Detayı

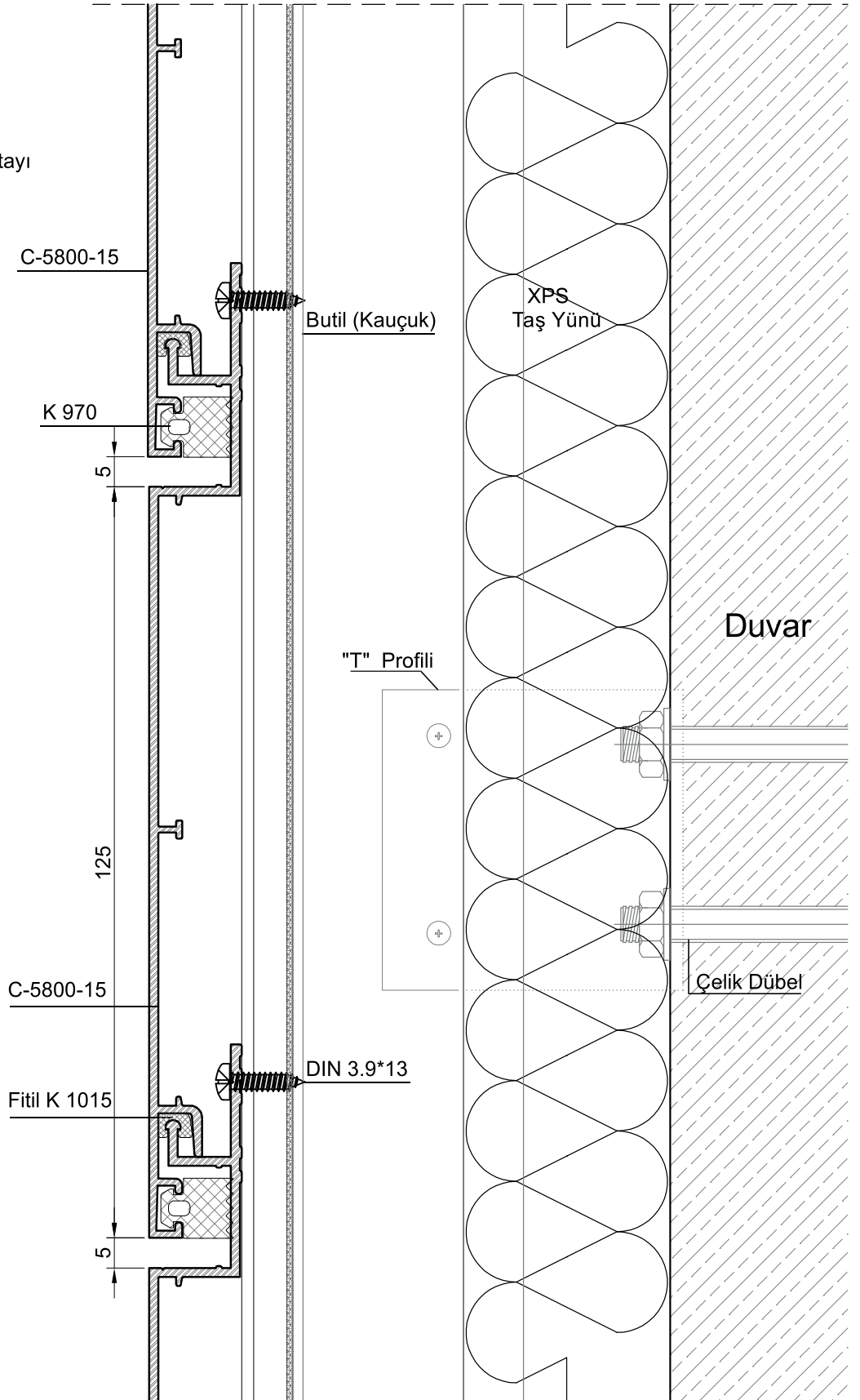

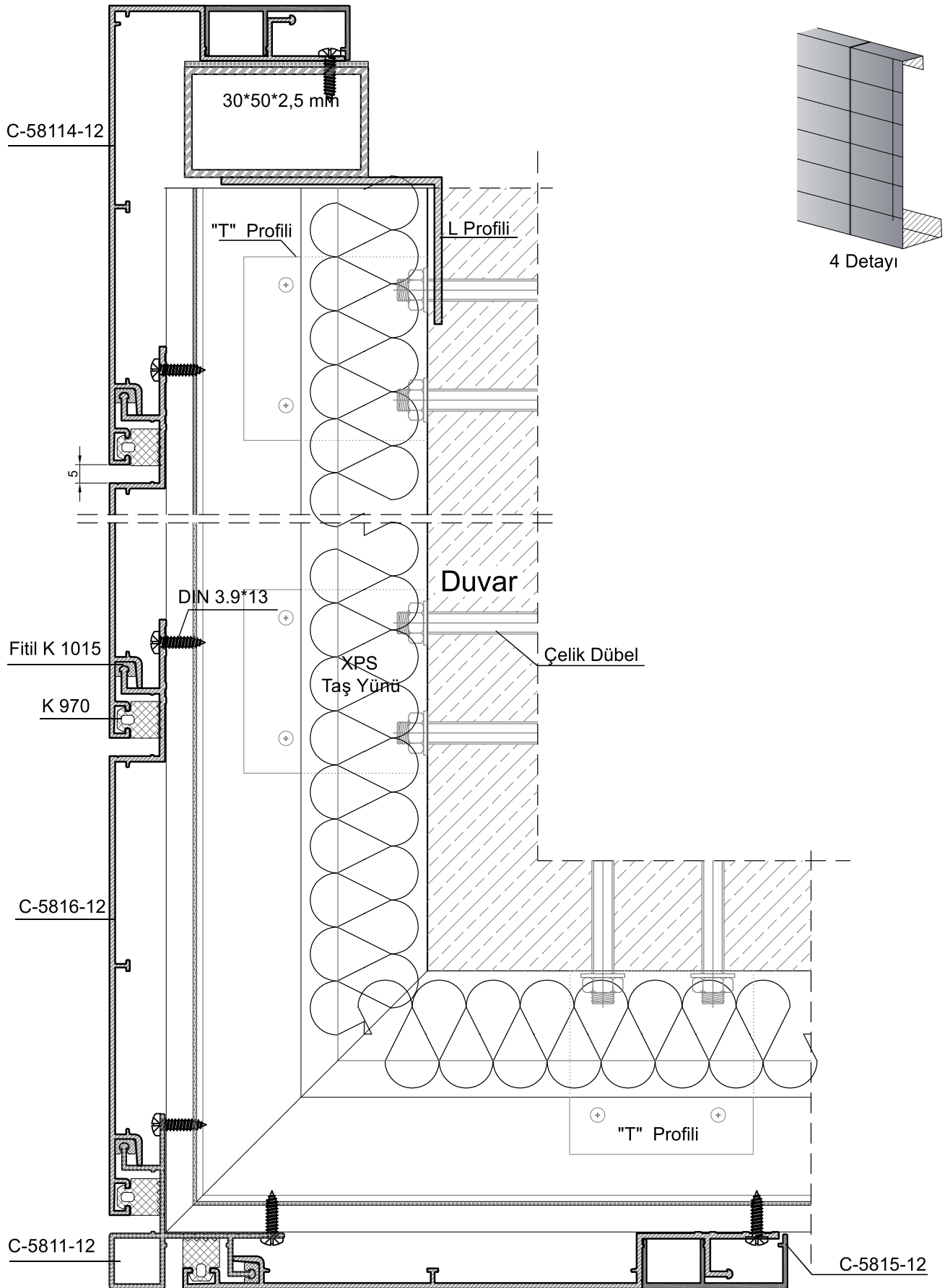

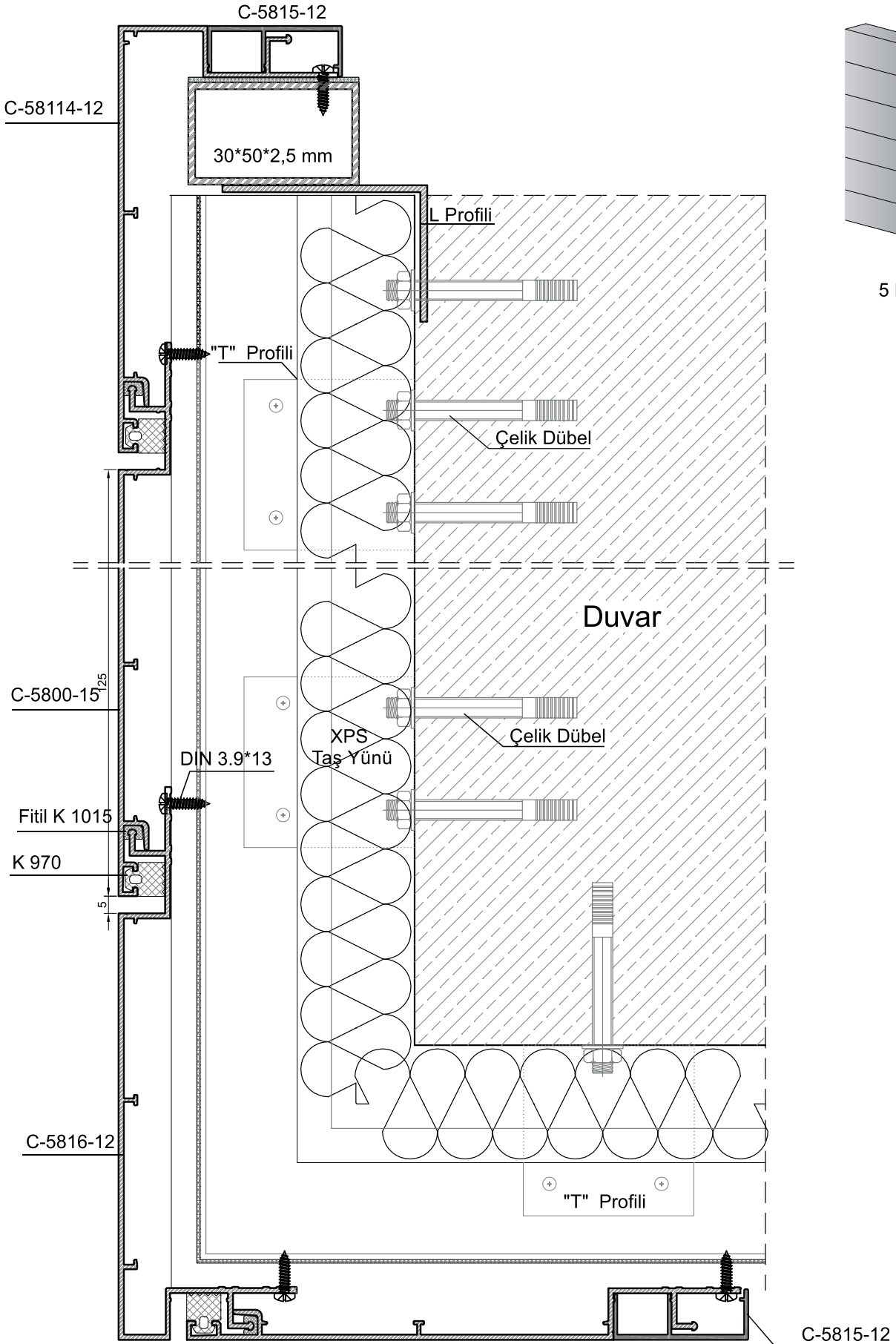

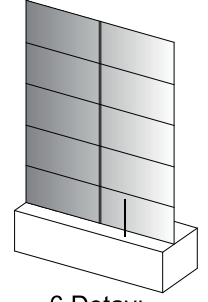

6 Detayı

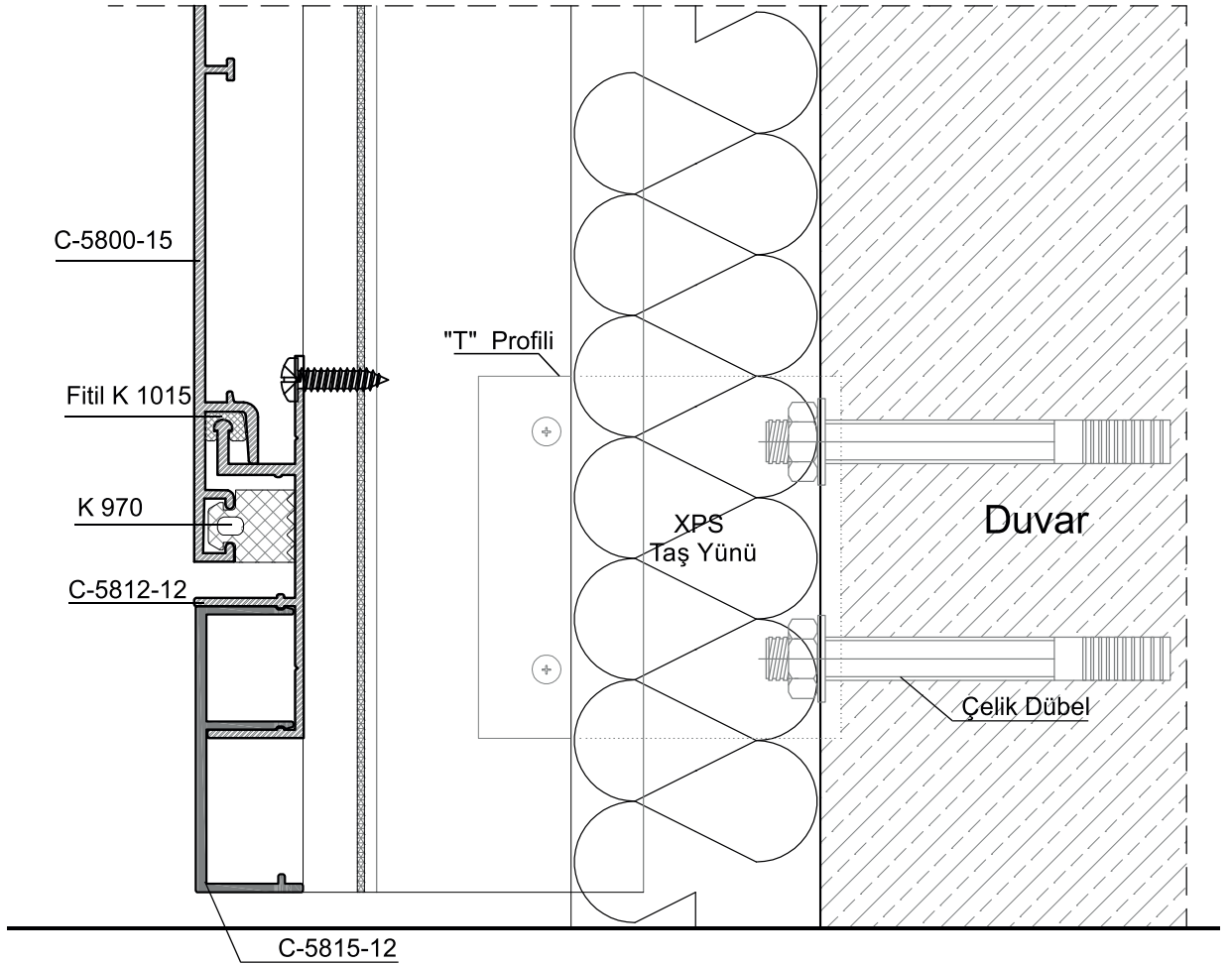

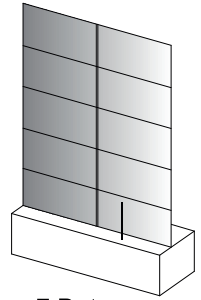

7 Detayı

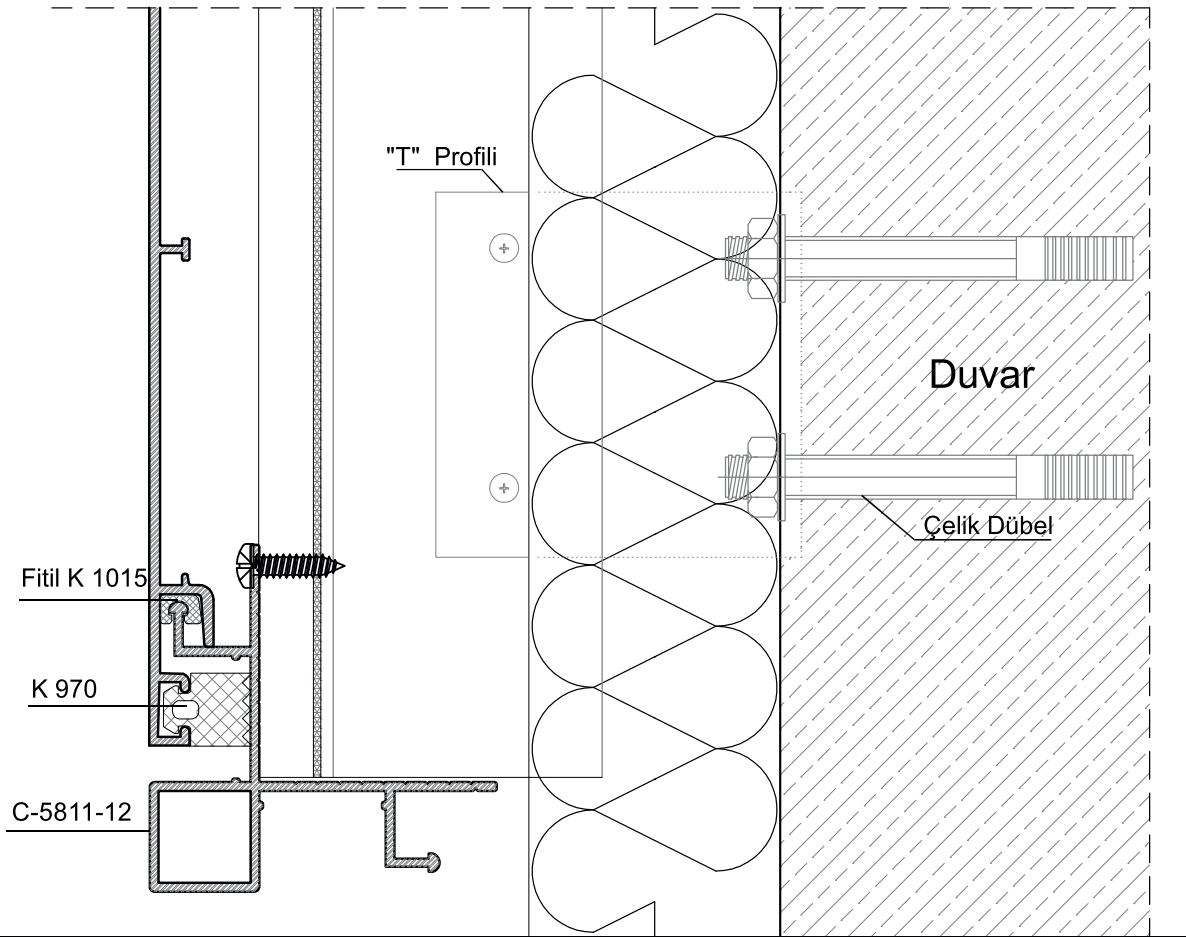

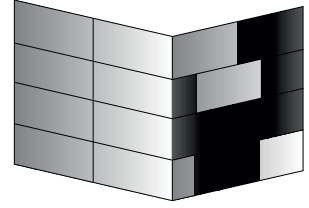

8 Detayı

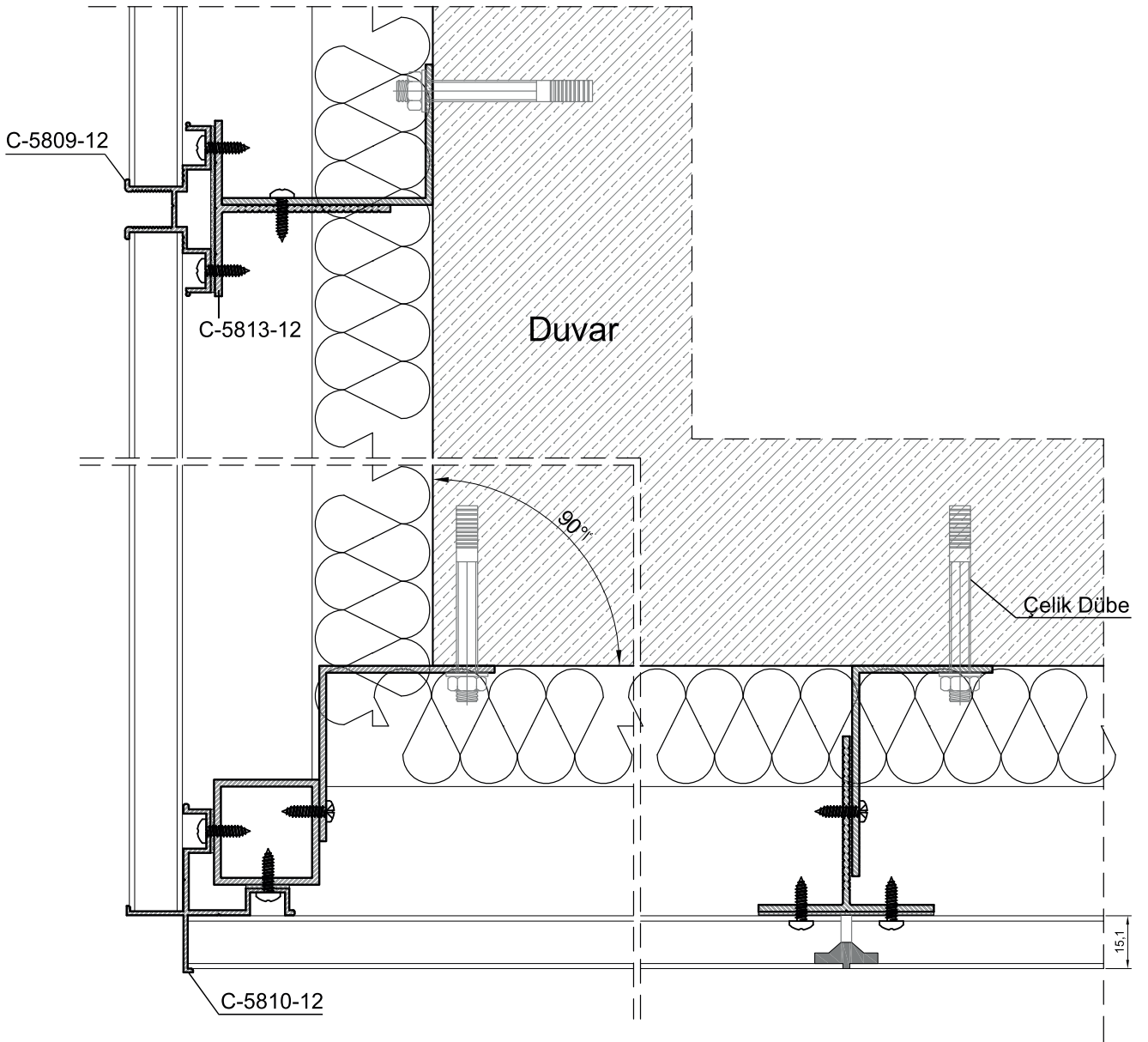

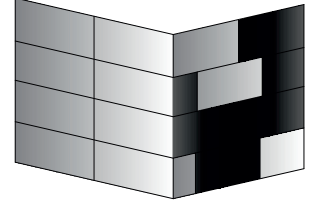

9 Detayı

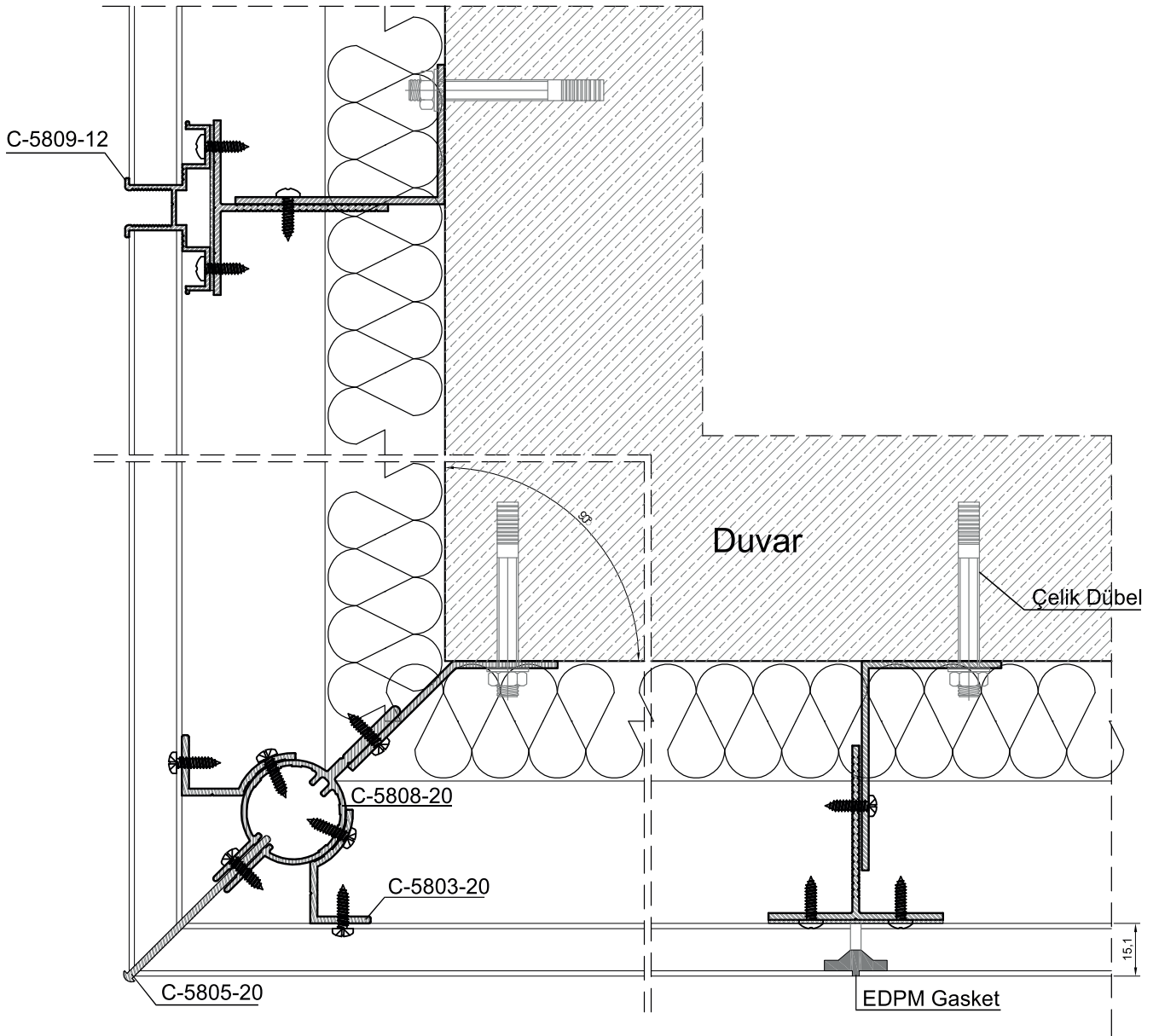

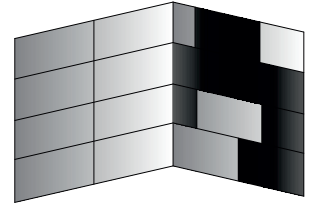

10 Detayı

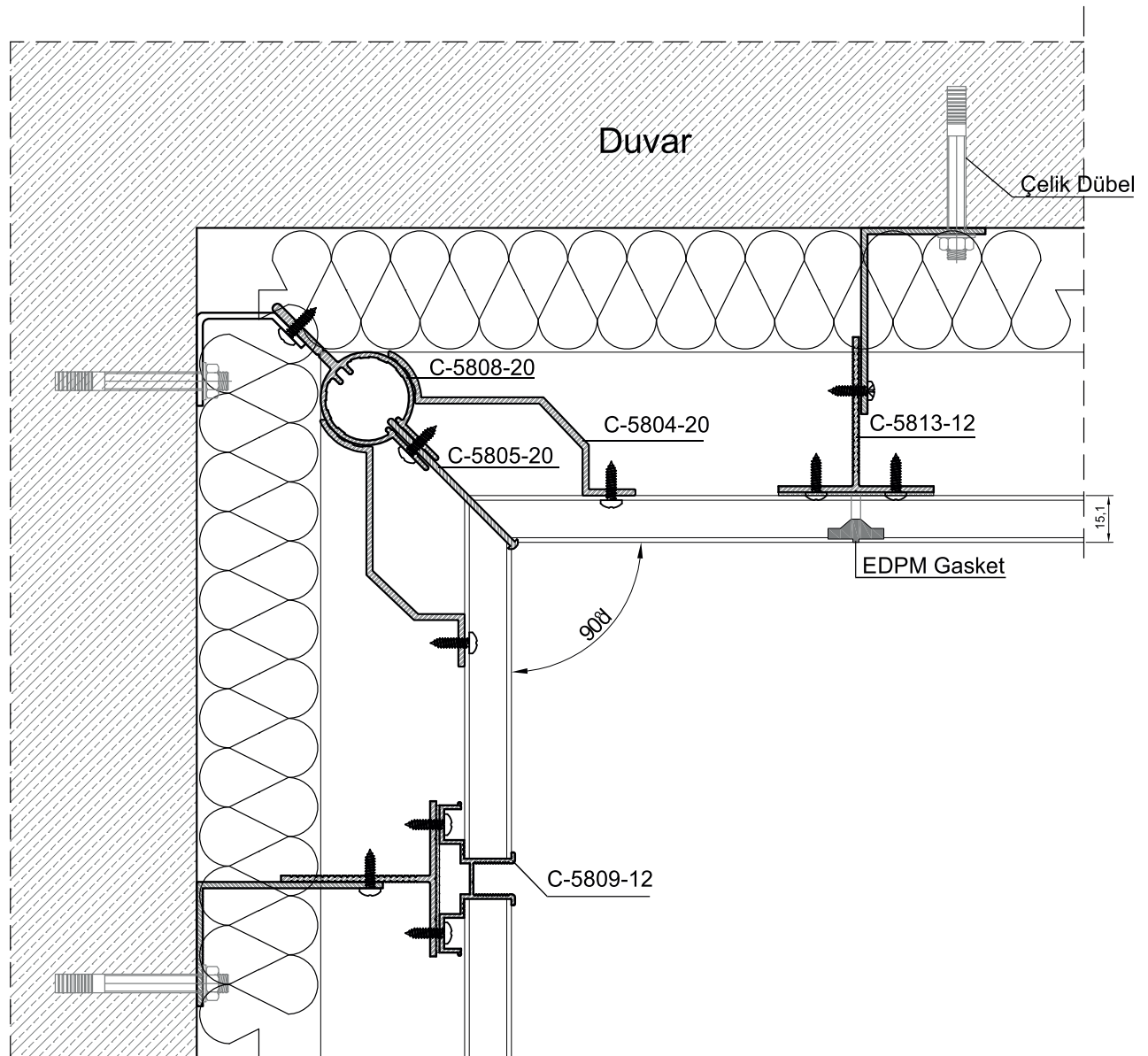

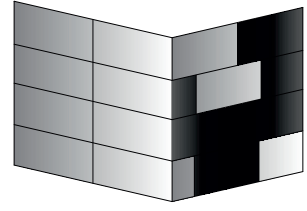

11 Detayı

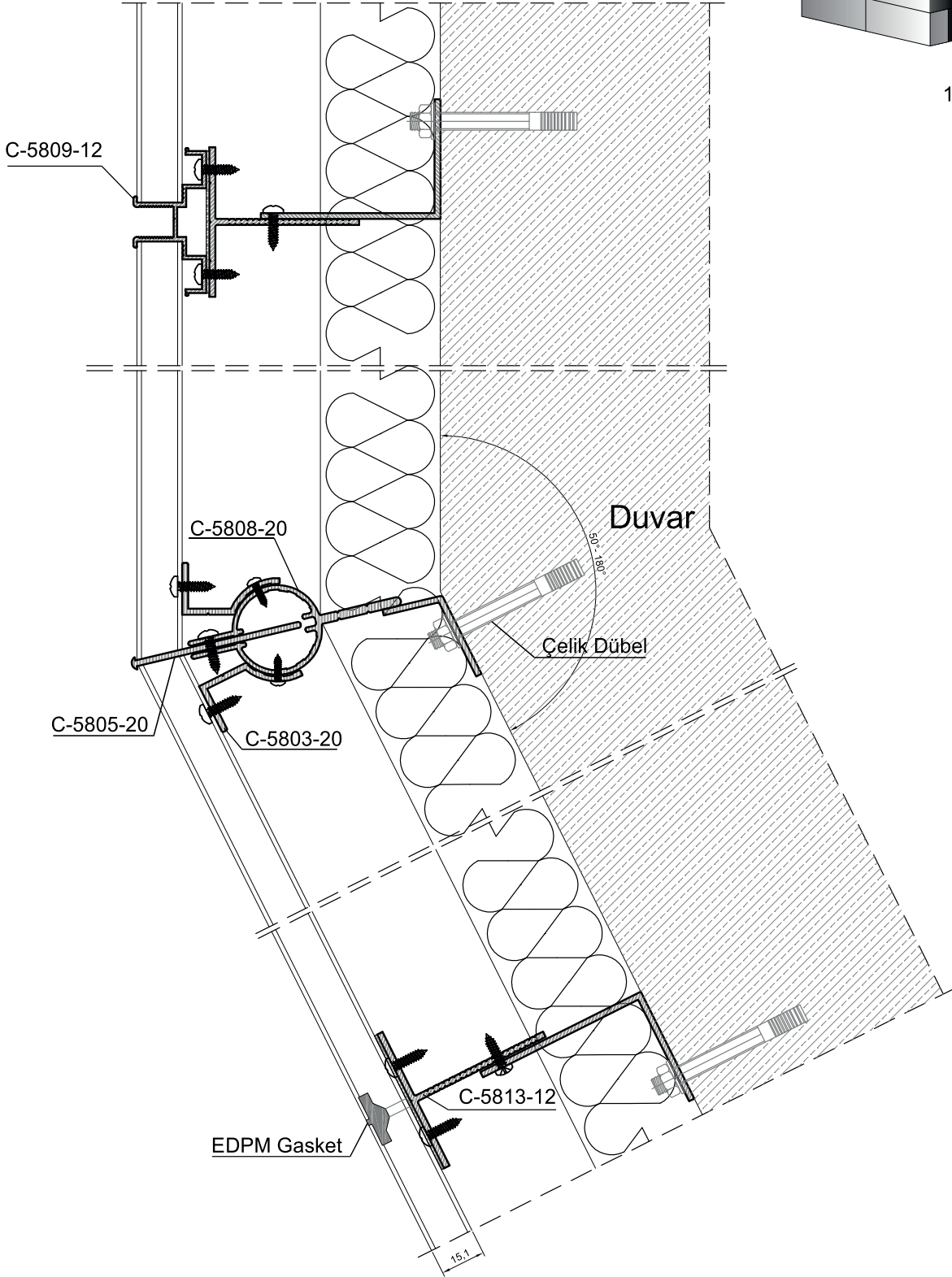

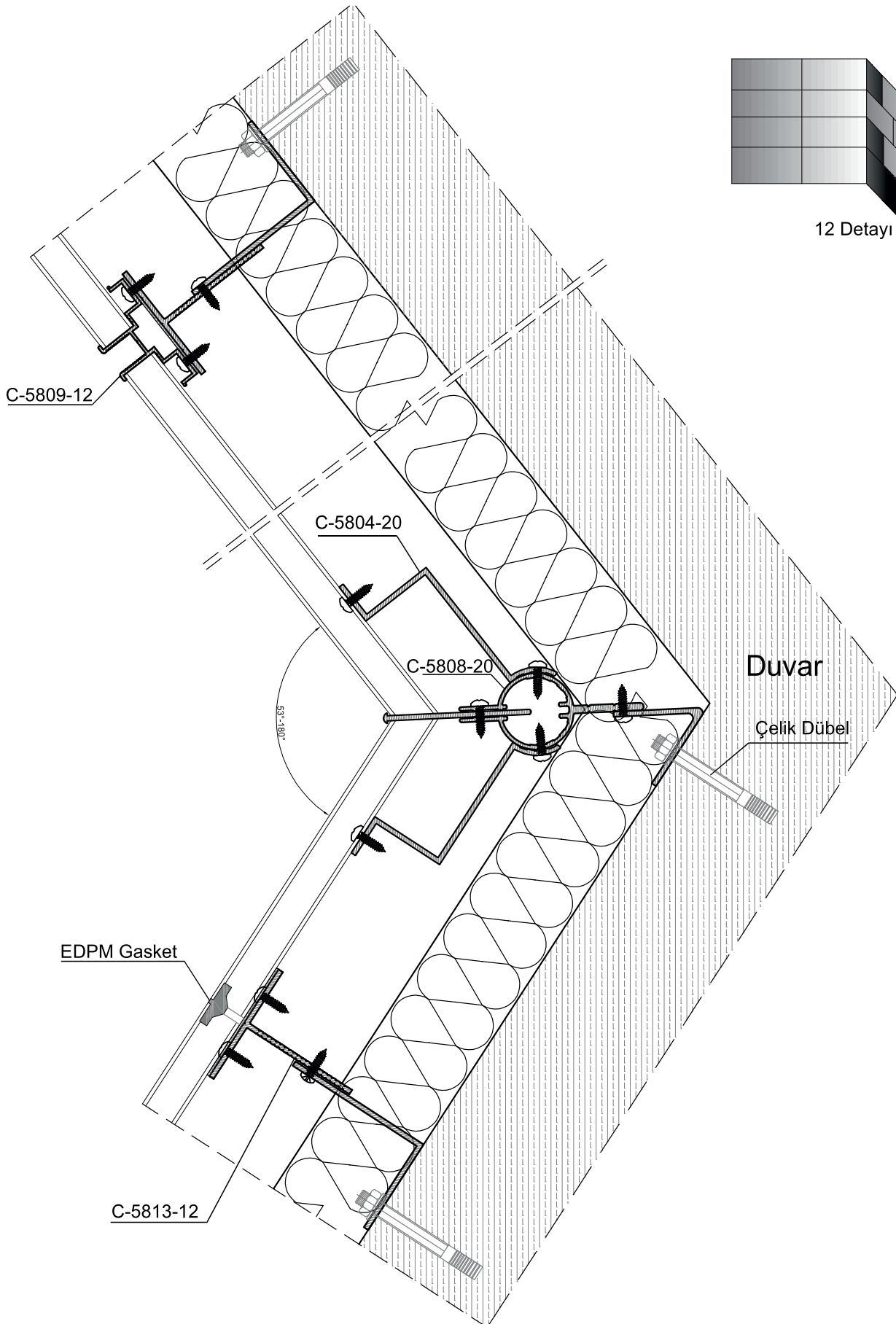

CLADDING

CEPHE KAPLAMASI



Ali Ersoy Mah. Çamlıtepe Cad.
No: 57/A Altındağ/ANKARA
T: +90 312 353 2002
F: +90 312 353 2003
@: info@ayderaluminum.com.tr
W: www.ayderaluminum.com.tr